

SUPER LED

PRODUCT FEATURES

- Our LED is integrated with driver IC and wide application
- Increases safety by better device reliability and visibility
- Save energy and maintenance cost
- Create more than one billion colors
- Entire cabinet comply with IP65
- Replace LED and display LED



APPLICATION

- Architectural lighting
- Landscape lighting
- Signage
- LED displayer



PRODUCT SPECIFICATIONS

Model number	Color	Millicandela	refresh rate	Applied voltage	Power consumption	View angle	weight (g)	Dimensions(mm) L x W x D	Operating temperature
SUPER LED APA-102C	Full Color 16777216	R 300-330 mcd G 420-460 mcd B 160-180 mcd	400 cycle	5VDC	0.2W (MAX:1W)	H:160	0.1	5x5x1.4	-40°C~70°C

PHYSICAL DIMENSIONS

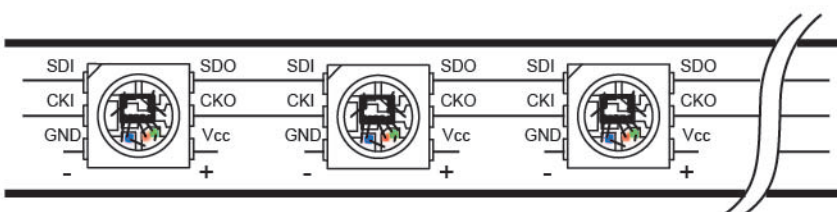
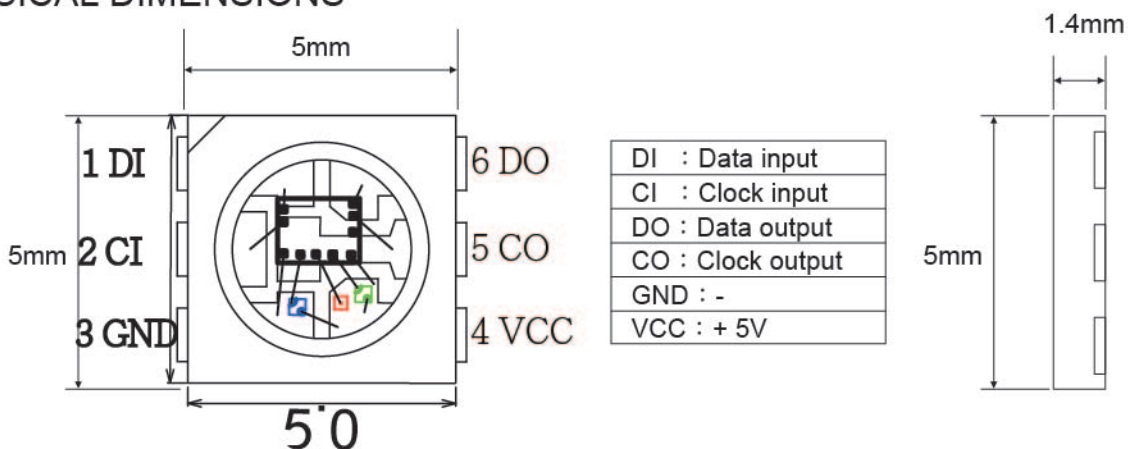

APA ELECTRONIC CO., LTD.
 8FL, NO. 317. SEC. 2, CHUNG SHAN RD.
 CHUNG HO, TAIPEI HSIEN, TAIWAN, R.O.C.
 TEL:+886-2-2240-9871 FAX:+886-2-2240-9870
 E-mail:apaneon@ms17.hinet.net

Tabdem N-LED

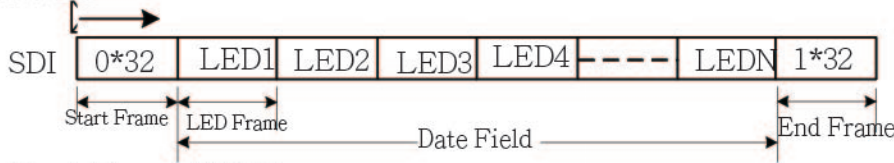

Start Frame 32 Bits

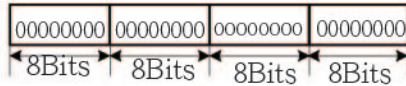

LED Frame 32 Bits



LED Frame 32 Bits

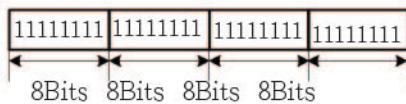

Global bit : 5-bit (32 level) brightness setting, while controlling R, G, B three-color constant current output value, if set the Global bit for the 10000 (16/31) is the output current is half again the original PWM settings.

DATA MSB ←→ LSB	Driving Current
00000	0/31
00001	1/31
00010	2/31
...	
11110	30/31
11111	31/31(max)

PWM input and output signals Relations

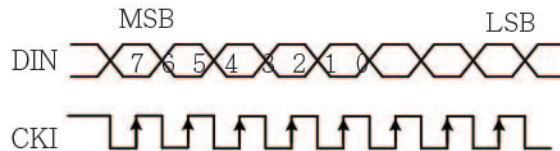

Data MSB—	Duty Cycle
00000000	0/256(min)
00000001	1/256
00000010	2/256
...	
11111101	253/256
11111110	254/256
11111111	255/256(max)

2).The number of pixels per second sent to CKI frequency (FCKI) minus the Start Frame bit divided by the number 40 the number of LED Frame bit 32, if CKI frequency (FCKI) to 512KHz, the pixel number (512000-40) /32=15998, if the 50 second update Views can be connected in series LED number 15998/50=319.To increase the number of cascaded IC CKI frequency to be increased.

(3).POLAR to empty , R, G, B for the negative output; POLAR access VSS, R, G, B is positive output.

(4).VEN: Self-detection

Data Field to the middle of 3bit were B, G, R in the MSB of the opposite phase, otherwise regarded as invalid data. VEN close to empty when the self-detection: when VEN VSS then activated self-detection.

(5).CSEL to empty when the CKO and CKI RP :CSEL connected with VSS when the CKO compared with CKI.

RELIABILITY PLAN:

* The reliability of products shall be satisfied with items listed below.

Confidence Level : 90 % , LTPD : 10 %

No	Test Item	Description & Condition		Sample size	Ac/Re
1	Solderability	Tsld =235±5°C, 10sec,	1 time	22	0/1
2	Low/ High Temperature Storage	Ta = -40 °C / Ta = 100 °C	1000 hrs	22	0/1
3	ESD HMB Contact Discharge	V=2000V : tr=10ns	45times	3	0/1
	Air Discharge	V=+2K,-2KV: tr=1ns	10times	3	0/1
4	Temperature Cycle	-40°C ~ 25°C ~ 100°C ~ 25 °C 30min 5min 30min 5 min	300 cycles	22	0/1

CAUTIONS:

(1)Storage

- Before opening the package :
The LEDs should be kept at 30°C or less and 30%RH~85%RH. The LEDs should be used within a year. When storing the LEDs, moisture proof packaging with desiccant (Silica gel)is recommended.
- After opening the package :
The LEDs should be kept at 30°C or less and 30%RH~70%RH.The LEDs should be soldered within 168hours (7days) after opening the package. If unused LEDs remain, they should be stored in moisture proof packages, such as sealed containers with packages of moisture desiccant (Silica gel), or reseal the moisture proof bag again.
If the moisture desiccant (Silica gel)has faded away or the LEDs have exceeded the storage time, baking treatment should be performed using the following conditions.
Baking treatment: 24 hours at 60°C on tap and reel, 7 hours at 125°C have no reel&tap.
Please avoid conditions which may cause the LED to corrode, tarnish or discolor. This corrosion or discoloration might lower solderability or might effect on optical characteristics.-Please avoid rapid transitions in ambient temperature, especially in high humidity environments where condensation can occur.
- Moisture Proof package
When moisture is absorbed into the SMT package it may vaporize and expand during soldering. There is a possibility that this can cause exfoliation of the contacts and damage to the optical characteristics of the LEDs. For this reason, the moisture proof package is used to keep moisture to a minimum in the package. A package of a moisture desiccant (silica gel)is inserted into the moisture proof bag-The silica gel changes its color from blue to pink as it absorbs moisture.

(2)Static Electricity

- Static electricity or surge voltage damages the LEDs. It is recommended that a wrist band or an anti-electrostatic glove and shoe be used when handling the LEDs.
- All devices, equipment and machinery must be properly grounded. It is recommended that measures be taken against surge voltage to the equipment that mounts the LEDs.
- when inspecting the final products in which LEDs were assembled, it is recommended to check whether the assembled LEDs are damaged by static electricity or not. It is easy to End static-damaged LEDs by a light-on test or a V_F test at a lower current (below 1 mA).
- Damaged LEDs will show some unusual characteristics such as the leak current remarkably increases, the forward voltage becomes lower, or the LEDs do not light at the low current. (Criteria : $V_F > 2.0V$ at $I_F = 0.5mA$.)

(3)Heat Generation

- Please consider the heat generation of the LED when making the system design that it's very importance. The coefficient of temperature increase per input electric power is effected by the thermal resistance of the circuit board and density of LED placement on the board, and other components. It is necessary to avoid intense heat generation and operate within the maximum ratings given in this specification.
- The operating current should be decided after considering the ambient maximum temperature of LEDs.

(4)Others

- Care must be taken to ensure that the reverse voltage will not exceed the absolute maximum rating when using the LEDs with matrix drive.
- The LED light output is strong enough to injure human eyes. Precautions must be taken to prevent looking directly for more than a few seconds. Flashing lights have been known to cause discomfort in people; you can prevent this by taking precautions during use. Also, people should be cautious when using equipment that has had LEDs incorporated into it.

SOLDERING CONDITIONS:

(1) Recommended Re-flow profile

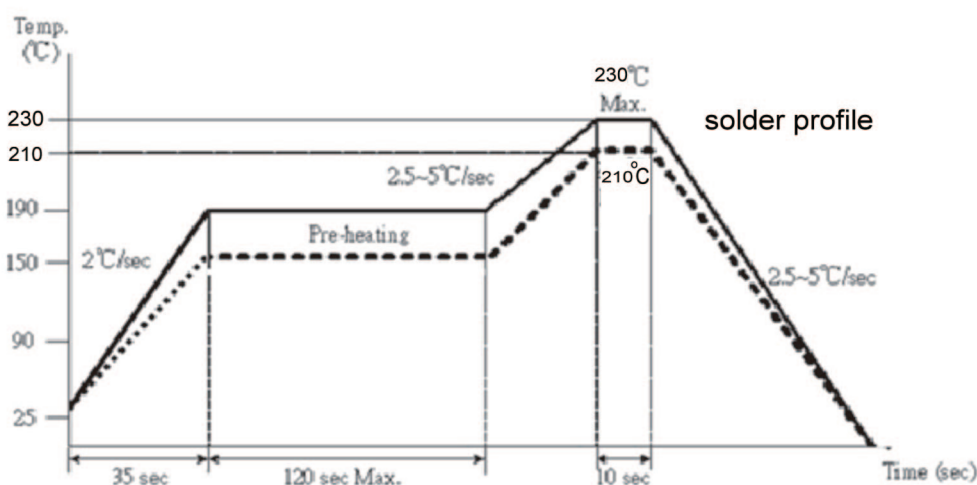

Super Led APA-102C



APA ELECTRONIC CO., LTD.
8FL, NO. 317. SEC. 2, CHUNG SHAN RD.
CHUNG HO, TAIPEI HSIEN, TAIWAN, R.O.C.
TEL:+886-2-2240-9871 FAX:+886-2-2240-9870
E-mail:apaneon@ms17.hinet.net

SUPER LED

Outline Drawing

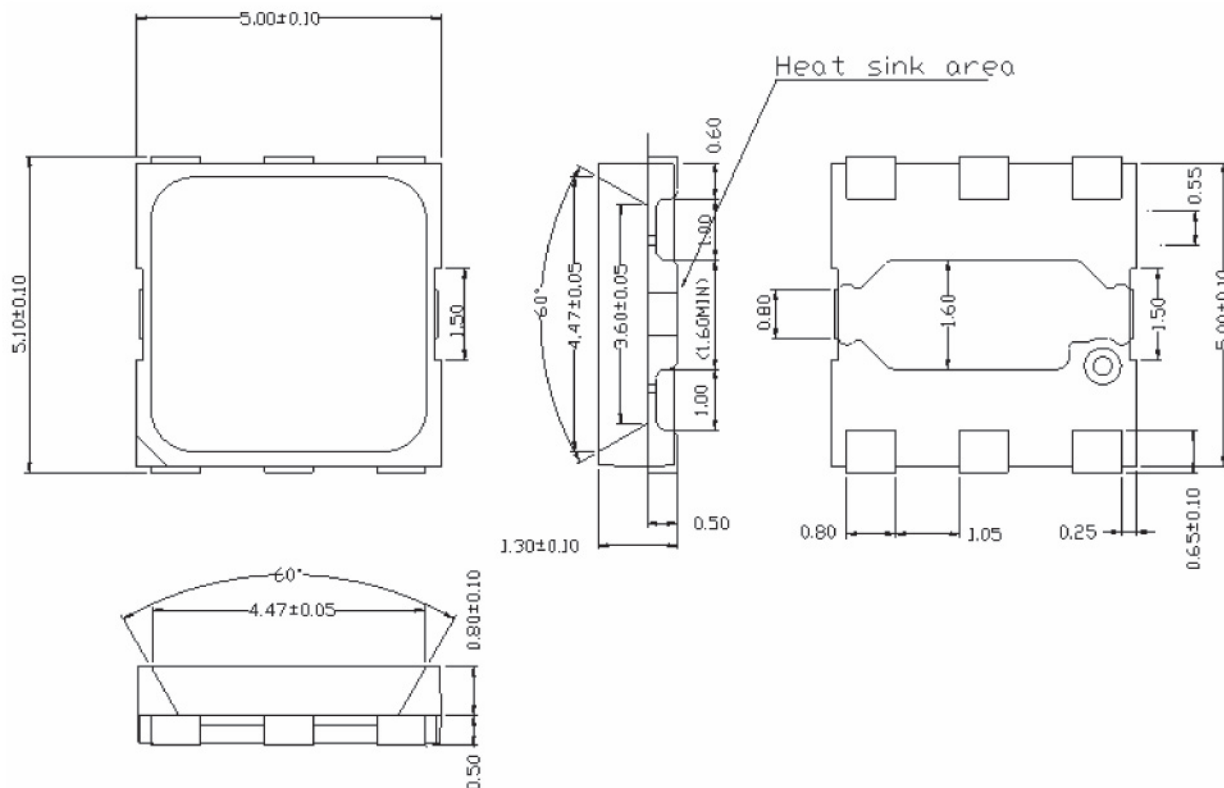

Pin Assignment

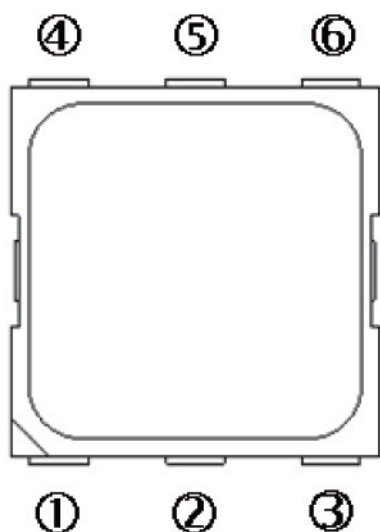

Front View

Back view

Pin No.	Function
1	Data In
2	Clock In
3	V _{SS}
4	Data Out
5	Clock Out
6	V _{DD}
(G)	N/A if floating GND & heat dissipation if soldered.

REEL PACKAGE:

Pull Direction:

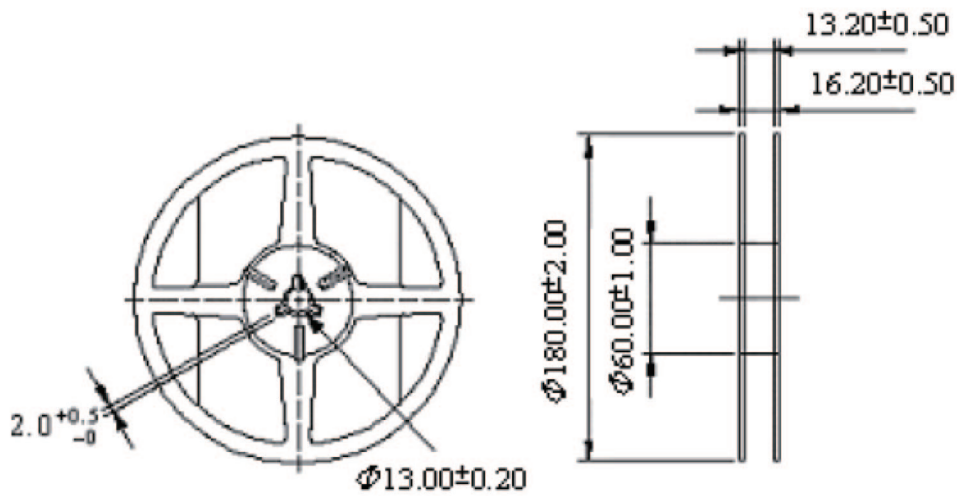
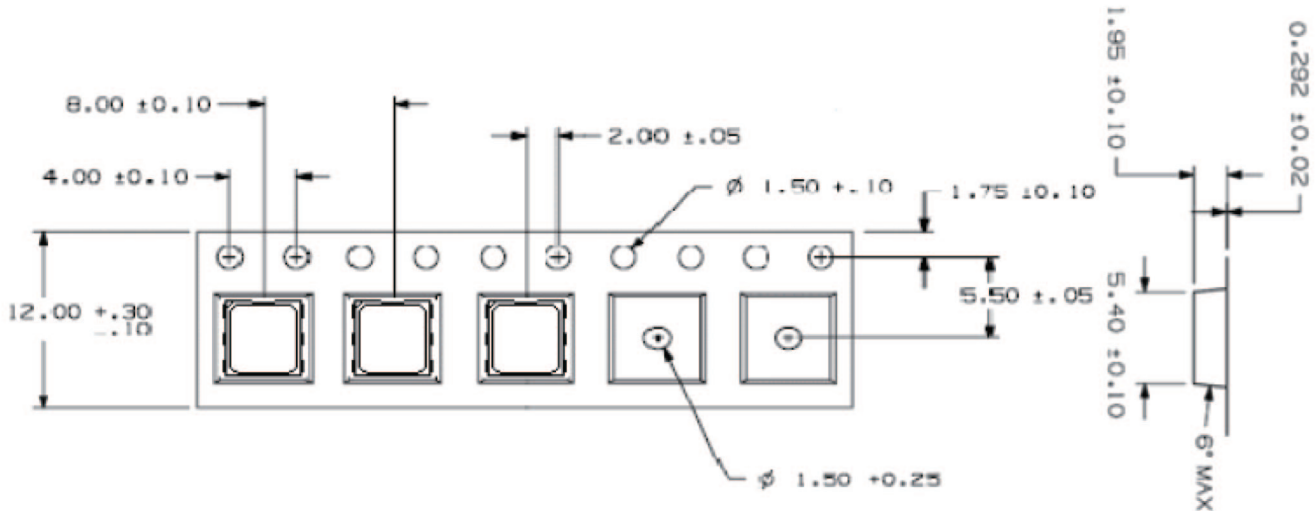
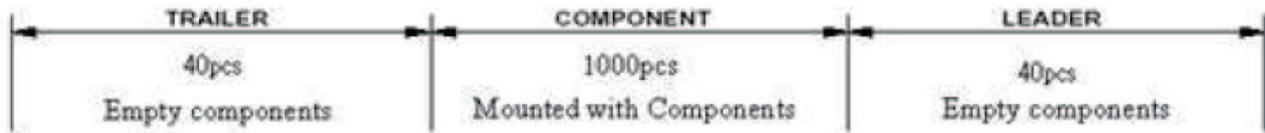

Note:

1. Unit: mm
2. 1,000 pcs / reel

Super Led APA-102C



APA ELECTRONIC CO., LTD.
 8FL, NO. 317, SEC. 2, CHUNG SHAN RD.
 CHUNG HO, TAIPEI HSIEN, TAIWAN, R.O.C.
 TEL:+886-2-2240-9871 FAX:+886-2-2240-9870
 E-mail:apaneon@ms17.hinet.net

SHIPPING PACKAGE:

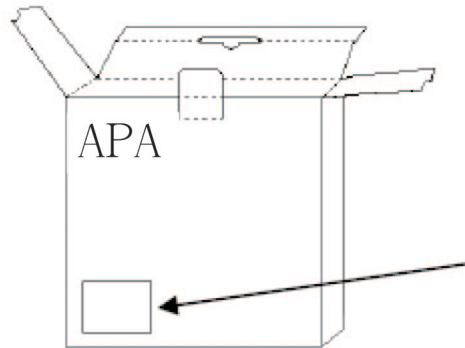
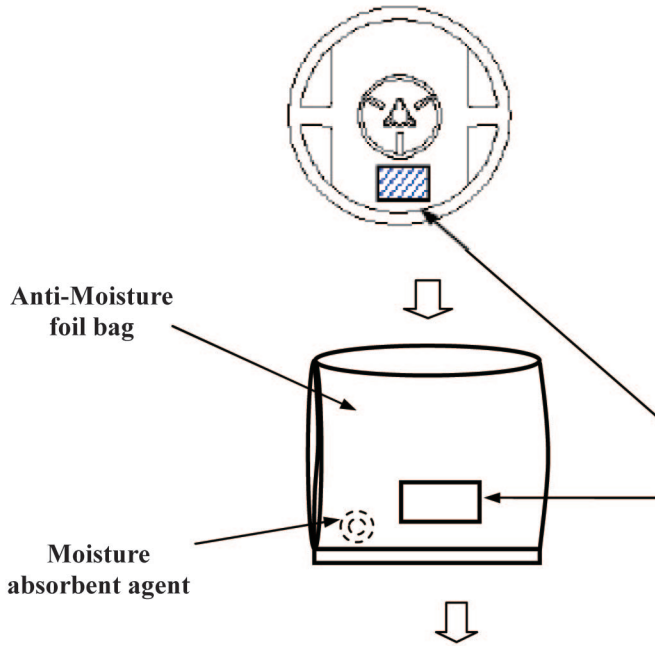

APA

QTY: 5000PCS

DATE: 2012/06/01

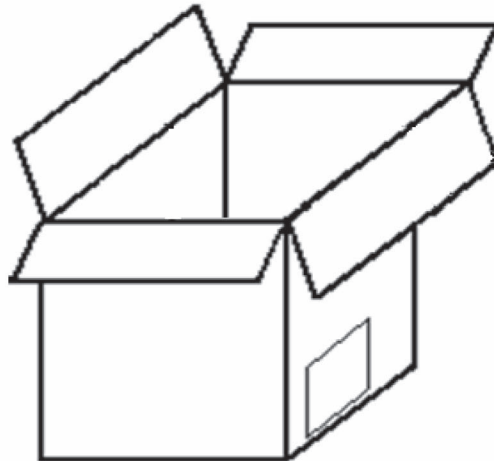

APA

QTY: 50000PCS

DATE: 2012/06/01

APA ELECTRONIC CO., LTD.

TEL: 886-2-2240-9871

FAX: 886-2-2240-9870

Note:

1. 1000 pcs (max.) / reel
2. 5 reels / box
3. 10 box / carton

Super Led APA-102C



APA ELECTRONIC CO., LTD.
8FL, NO. 317. SEC. 2, CHUNG SHAN RD.
CHUNG HO, TAIPEI HSIEN, TAIWAN, R.O.C.
TEL: +886-2-2240-9871 FAX: +886-2-2240-9870
E-mail: apaneon@ms17.hinet.net